

SILVER SD SERIES WHITE LIGHT ILLUMINATOR

S-S123D-W

- High power white light illuminator provides high power illumination for CCTV cameras. Delicate housing and strong materials for great heat dissipation ability and zero maintenance.
- 30,000 hours lifetime of LED.
- 3 years warranty.



Professional Design

- Two stages of constant current circuit avoid LED away from instantly impulse impact when started.
- Low failure rate of products is guaranteed by the professional in-house optimized independent circuit technology, which has been widely used in our LED illuminators for more than 5 years.
- Wide edge of silica gel circle and water stop line ensure IP66 waterproof and dustproof level.
- Twice direct cooling heat sink processing enable to increase the cooling coefficient and prolong the service life of the product.
- Patent design hexagonal spherical light sensor more accurately responses ambient brightness and improves accuracy of automatic light control.
- Flexible angle adjustable bracket can extend the illuminance range widely.
- Robust cooling fin design is available the illuminator working at -40°C to 50°C.
- Super energy saving circuit with low electrical power consumption.

Qualified Material

- Super power dot-matrix LED with strong light effect, long service life and low light decline feature.
- High efficient twice optical lens processing achieves 90% of the luminous efficiency.
- The housing adopts high thermal conductivity aluminum to enhance heat dispersion property.
- Stainless steel bracket and screw ensure low maintenance.

Wide Range of Application

- Recommended for security at ports, railway systems, border, prisons, traffic LPR/ANPR, ITS as well as large public places lighting.

Basic Function

- To improve performance of the weak light camera, thereby enhancing the picture effects at night.
- Conventional night monitoring
- The function of video analysis at night
- Reduce signal noise and other image distortion
- Reduce the network bandwidth requirements
- Energy saving by power factor correction
- Reduce the equipment cost
- Lower cost of installing and wiring

Viewing picture at night



With white light

Without white light

SILVER SD SERIES WHITE LIGHT ILLUMINATOR

Picture



Product certificate



Technical Specification

LED type	36pcs high power white light LED
Color temperature	3000-3500K/5500-6000K
Luminous Flux	7200lm
Voltage	AC85-265V/DC12V/AC24V
Power consumption	78W
Day and night switch	Auto (build in photocell)
Mounting	Wall mounting "U" bracket
Temperature	-40°C to 50°C
Grade of protection	IP66
Color	Beige
Housing	Aluminium
Panel	High light transmittance toughened glass
N.W	4.5KG
G.W	5KG
Dimension	378*135*91mm
Packing dimension	180*230*590mm

Drawing

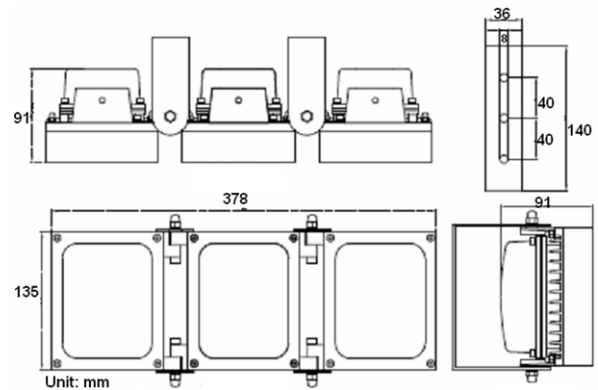

Model for selection

Model	Beam angle	Viewing distance
S-S123D-15-W	15° - 45°	320m-200m
S-S123D-30-W	30° - 90°	280m-170m
S-S123D-45-W	45° - 135°	200m-130m
S-S123D-60-W	60° - 180°	170m-110m
S-S123D-90-W	90° - 200°	130m- 90m
S-S123D-120-W	120°-230°	80m-50m

*Viewing distance is tested by Sony 1/3 CCD Camera with 0.01LUX. .

To achieve the distance needed, please pay attention to your camera specification and lens before purchase. It is normal phenomenon that distance may vary due to different cameras and lens.