

Compound-eye LED White Light Illuminator S-SG20A-W



Product Overview

- Delivers high power white light for night time illumination, it's significantly improves monitor effects of night vision camera.
- Adopted with Compound-eye LED lens, the product performs more smoothly and evenly light spot radiation.
- Excellent color rendering index, truly reserve object colors.
- Innovating high-efficiency driver provides a zero maintenance product.
- Good heat dissipation and IP66 waterproof aluminum housing ensures efficient, reliable and continuous operation of LED.

Product Features

- Outstanding illumination performance
- Auto day/night switch, customize to be synchronized with camera
- To improve performance of night vision camera and enhance image quality
- IP66 waterproof, indoor/outdoor use
- Low temperature operate
- Lifetime 50,000 hours
- Energy saving technology
- 2 year warranty

Wide Application

Parking lot, Residence Community, Building, Road, Garden, Field

Viewing picture at night



With white light

Without white light

Compound-eye LED White Light Illuminator

Technical Specification

LED type: 20pieces high power white light LED
 Luminous flux: 2400lm
 Color temperature: 5000K-6500K
 Beam angle: 30 to 60°
 Beam distance: 70 to 50m
 Bracket: wall mount bracket
 Working voltage: 85-265V AC
 Power consumption: 26W
 Day/night switch: automatic
 Working temperatures: -30 to 50°C
 Protection level: IP66
 Color: beige
 Panel: tempered glass panel
 Housing: aluminum die-casting housing
 N.W: 1.8KG
 G.W: 2.1KG
 Dimension: L221*H172*W90mm
 Packing dimension: L250*H200*W120mm

Drawing

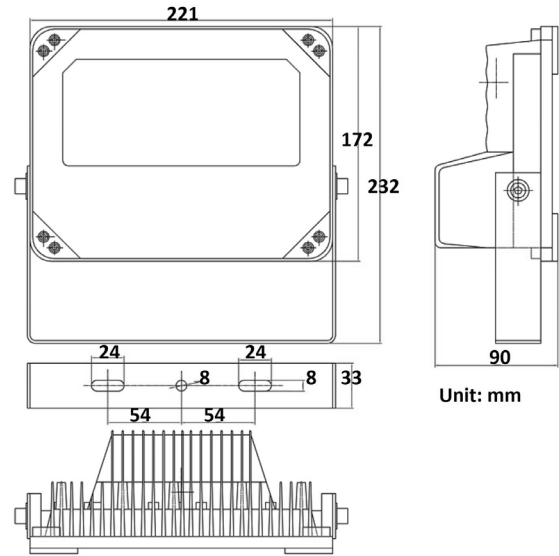

Model for Selection

Model	Beam angle	Viewing distance
S-SG20A-30-A-W	30°	70m
S-SG20A-45-A-W	45°	60m
S-SG20A-60-A-W	60°	50m

*Viewing distance is tested by Sony 1/3 CCD Camera with 0.01LUX.

*To achieve the distance needed, please pay attention to your camera specification and lens before purchase. It is normal phenomenon that distance may vary due to different cameras and lens.

Product Certificate

